

# BLACK◆DIAMOND

## Standard Series Gas Griddles - BDECTG Series

Black Diamond's Standard Series gas countertop griddles are designed for use with either natural or LP gas. Constructed of stainless steel front and sides that are fully welded, these units are able to stand the toughest of kitchen environments. Each unit includes tips for field conversion to LPG.



BDECTG-16/NG  
BDECTG-24/NG  
BDECTG-36/NG  
BDECTG-48/NG

### Standard Features

- ◆ Fully welded stainless steel front bullnose design with galvanized sides
- ◆ Fully welded stainless steel backsplash for extra durability
- ◆ 30,000 BTU per burner
- ◆ One U-shape stainless steel burner for every 12" griddle width
- ◆ Griddle plate is made up of 5/8" thick steel (3/4" for BDECTG-48 model)
- ◆ 3" wide grease trough for easy cleaning
- ◆ 4"-5" adjustable legs
- ◆ Separate gas valves for each burner with standing pilot ignition system
- ◆ Removable stainless steel drip tray for easy cleaning
- ◆ 3/4" rear NPT gas inlet
- ◆ ETL Listed and ETL Sanitation



Black Diamond warrants this product to be free of defects in materials and workmanship for period of 1 year from the date of original installation.

Model	Overall Width	Burners	Total BTU	Net Weight (lb)	Gross Weight (lb)
BDECTG-16/NG	16"	1	30,000	103	136
BDECTG-24/NG	24"	2	60,000	114	147
BDECTG-36/NG	36"	3	90,000	176	211
BDECTG-48/NG	48"	4	120,000	297	421

# BLACK◆DIAMOND

Standard Series Gas Griddles - BDECTG Series

## Plan View

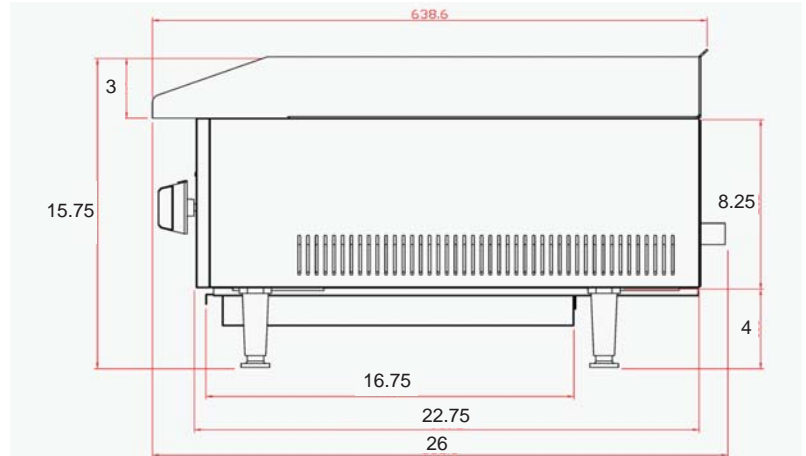
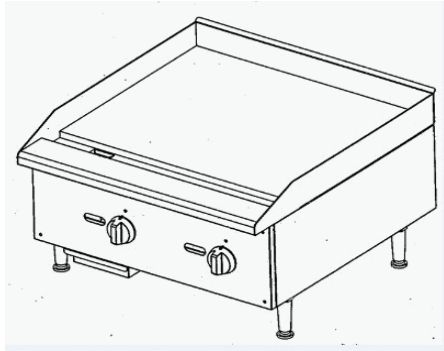

## Unit Dimensions (inches)

Model	Description	Width	Depth	Height
BDECTG-16/NG	16" Griddle	16	26	15.75
BDECTG-24/NG	24" Griddle	24	26	15.75
BDECTG-36/NG	36" Griddle	36	26	15.75
BDECTG-48/NG	48" Griddle	48	26	15.75

## Drip Tray (inches)

Model	Width	Depth	Height	Drip Tray Qty
BDECTG-16/NG	6.25	16.75	3	1
BDECTG-24/NG	6.25	16.75	3	1
BDECTG-36/NG	6.25	16.75	3	1
BDECTG-48/NG	6.25	16.75	3	1